

BRUGES

A391

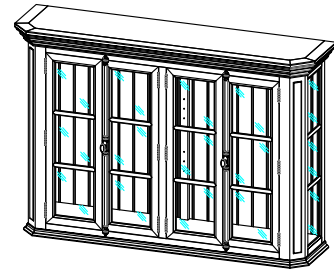

x1

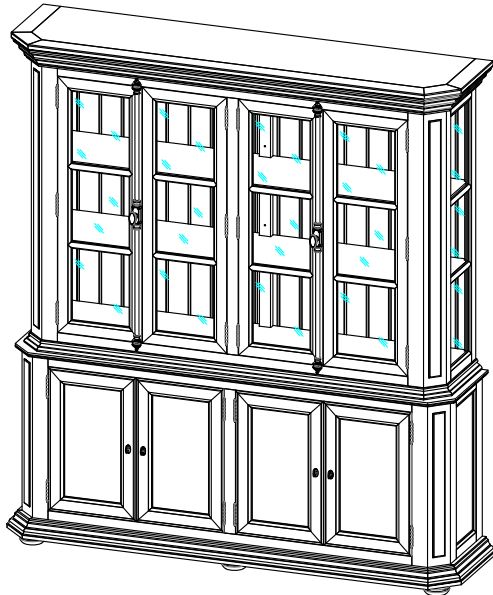
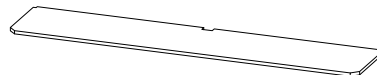

x2



Ø6

x12

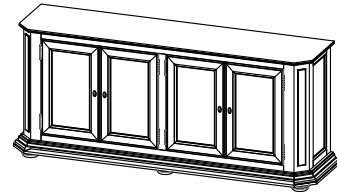

x1

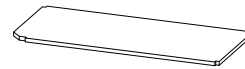

x2



Ø6

x8

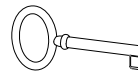

x4



M4x20

x6

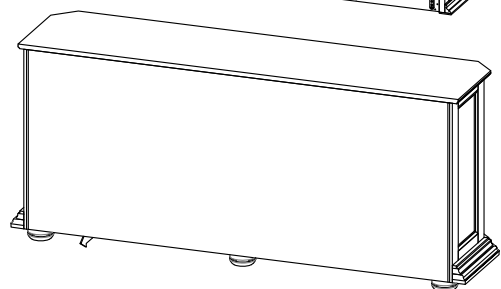
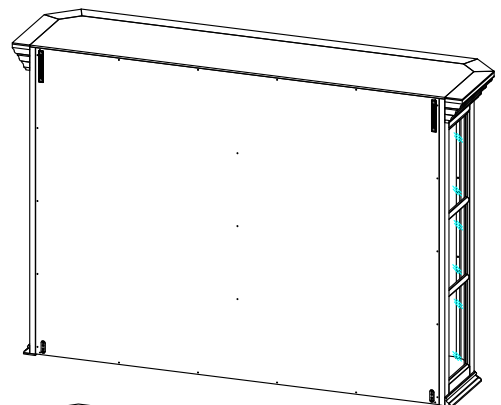
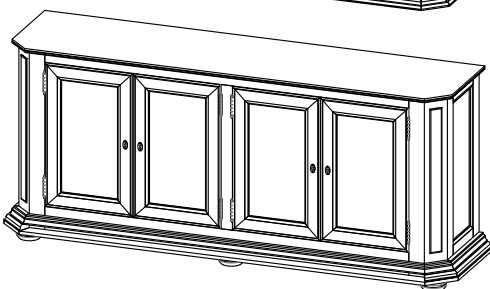
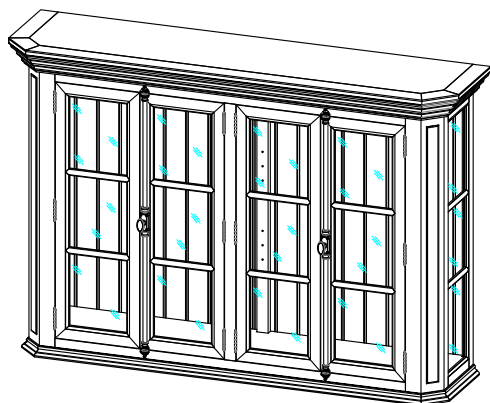

BRUGES

A391

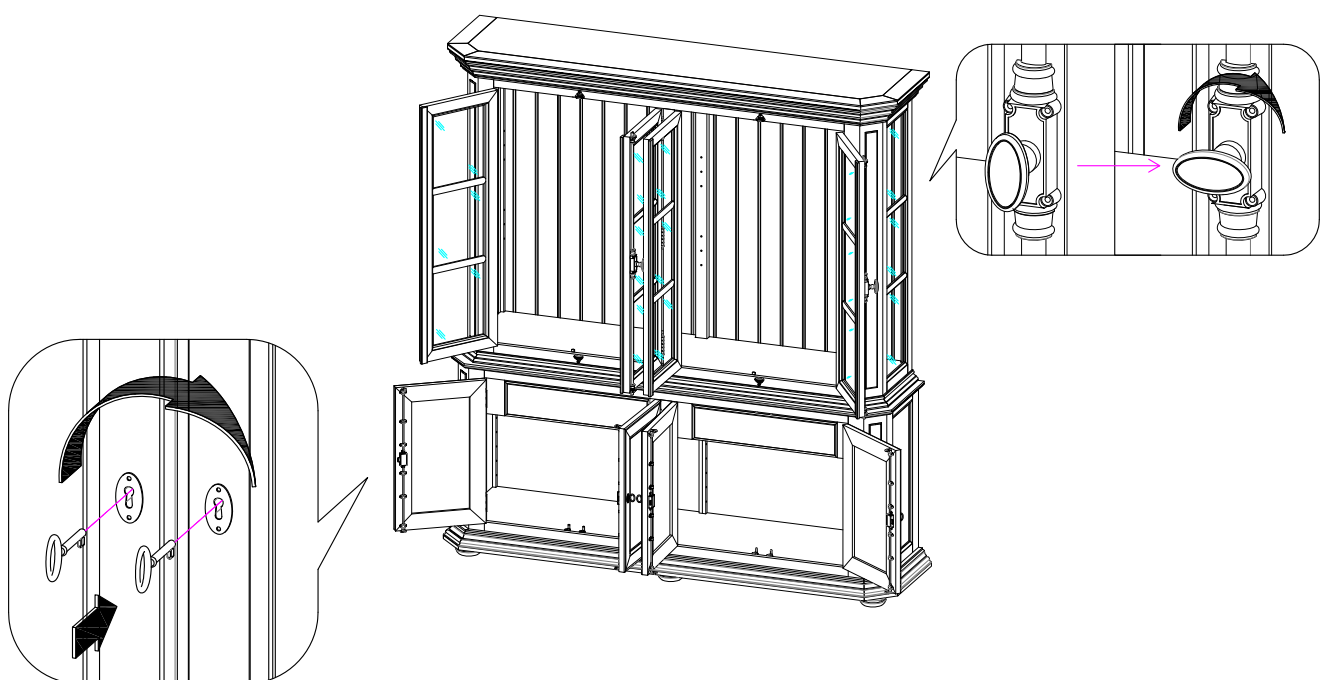
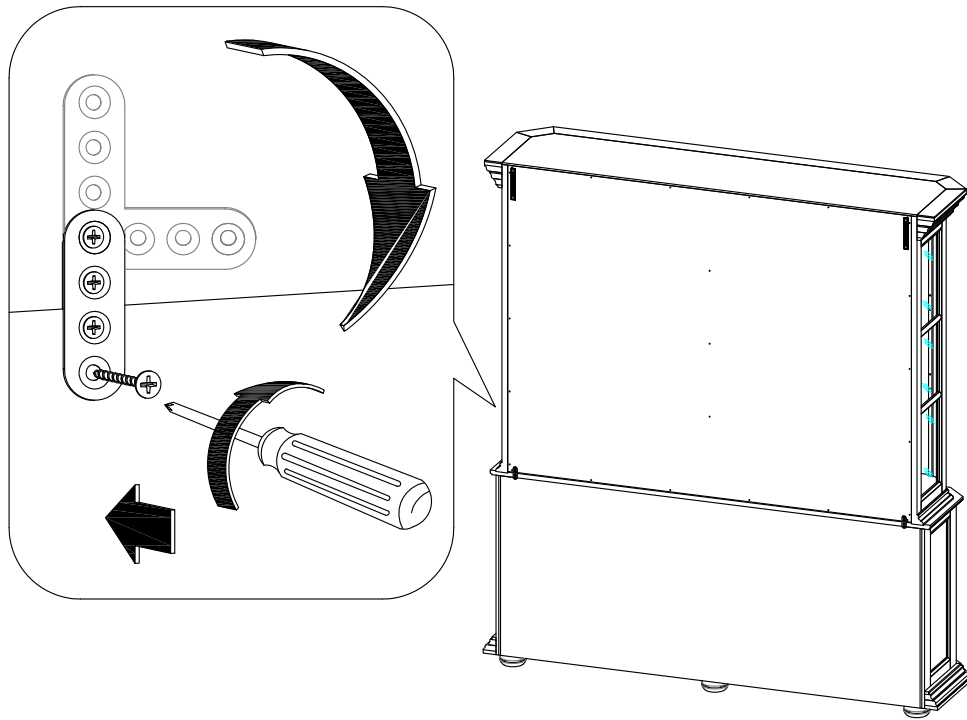

BRUGES

A391

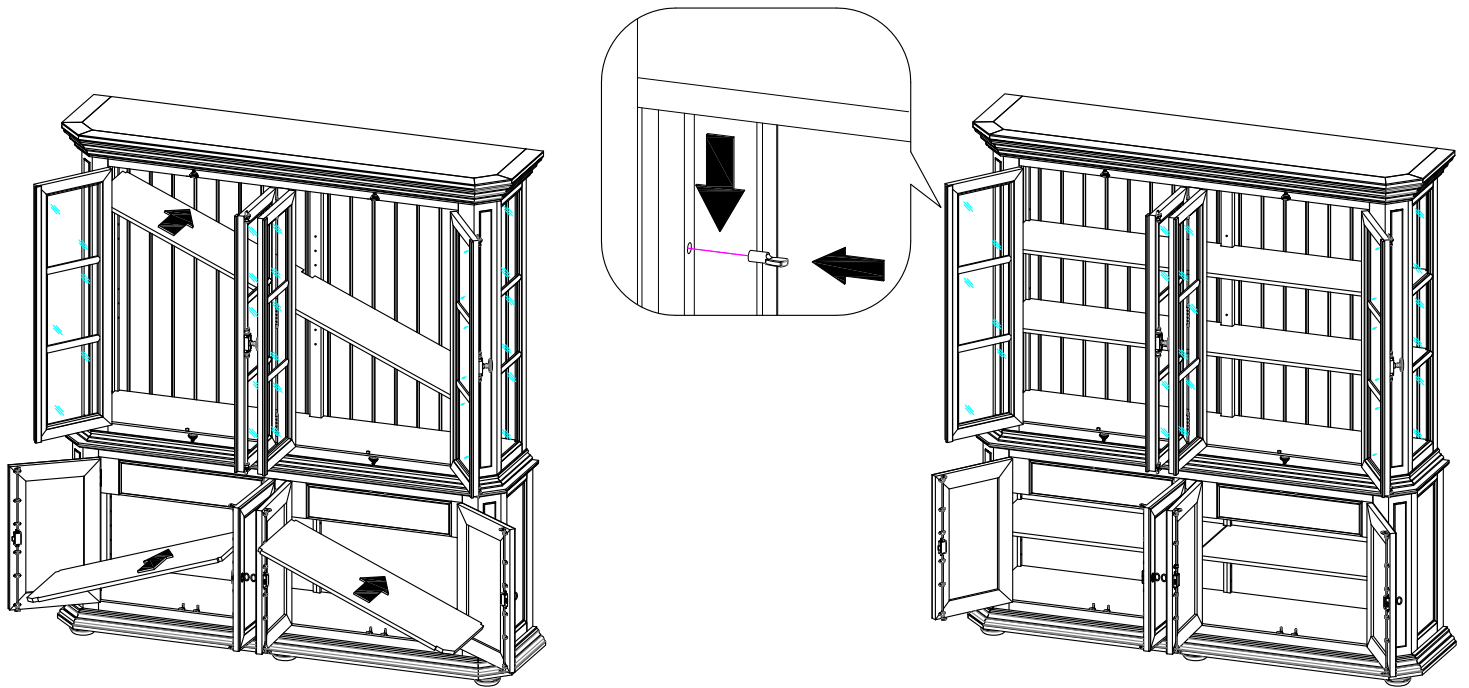

Anchoring Devices Instruction

Top panel

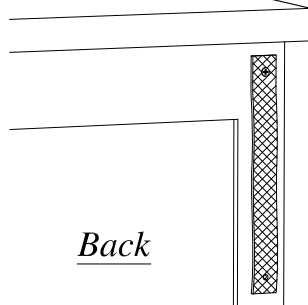

Back

WALL

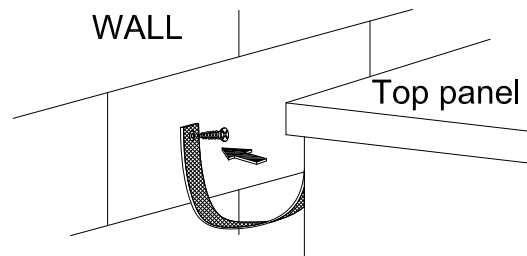

Top panel

Apply to all products which height over 60cm
Please note that extra wall fixings might be required depending on the wall construction

